



Varley Collection

Colours represented are to be used as a guide only.
Please refer to manufacturers swatch for a more accurate colour match.

Please note that colour shadings can vary slightly from each roll of fabric.
We cannot guarantee a precise match to these samples or between cut lengths and upholstered goods.

foamflex™
Award Winning Seating Technology

15/02/2022

VARLEY COVER GUIDE: STANDARD BACK ONLY

Please use this guide when ordering the following pieces to clarify cover options.

Corner Group: LH2, COR, RH2

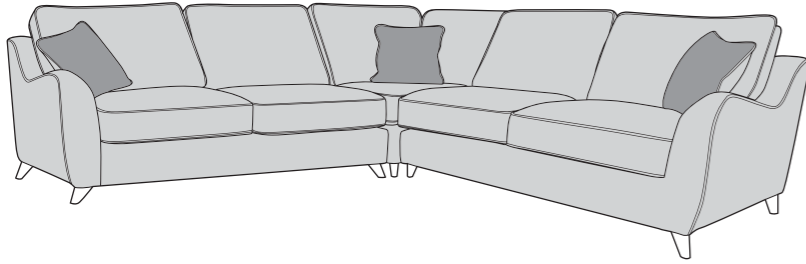

Corner Group: LH2, RFC, FST

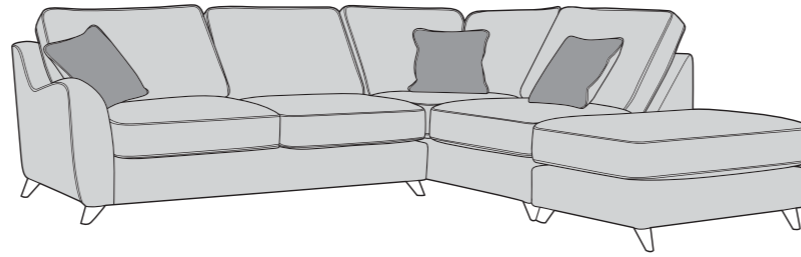

Corner Group: FST, LFC, RH2

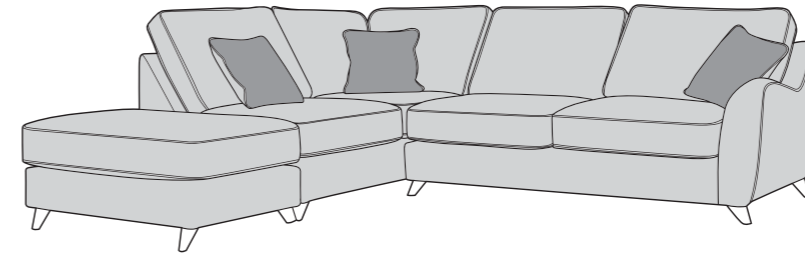

Corner Group: LH2, COR, RH1

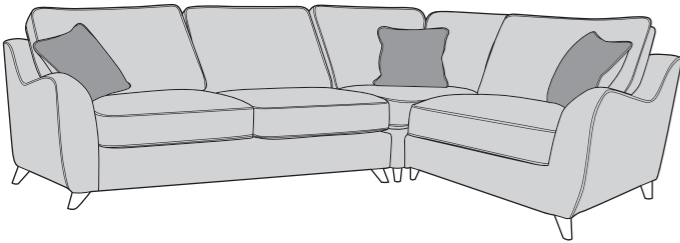

Corner Group: LH1, COR, RH2

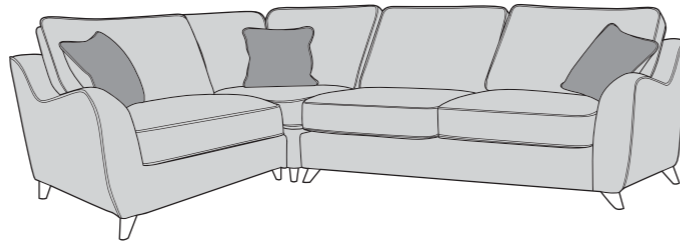

Corner Group: LH1, COR, RH1

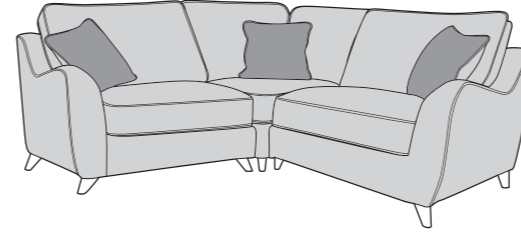

Armless Unit (ALU)

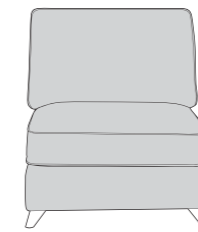

3 Seater Sofa (2ST)

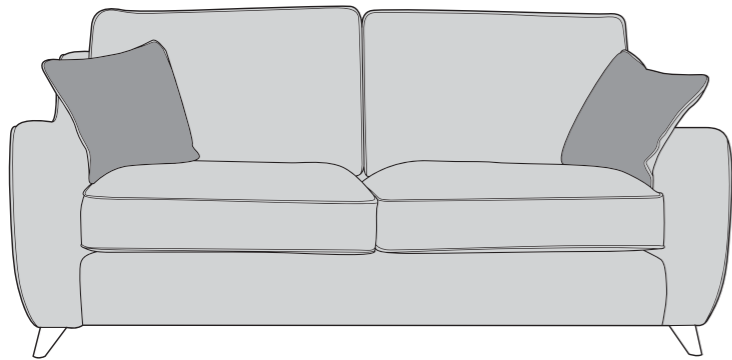

2 Seater Sofa (2ST)

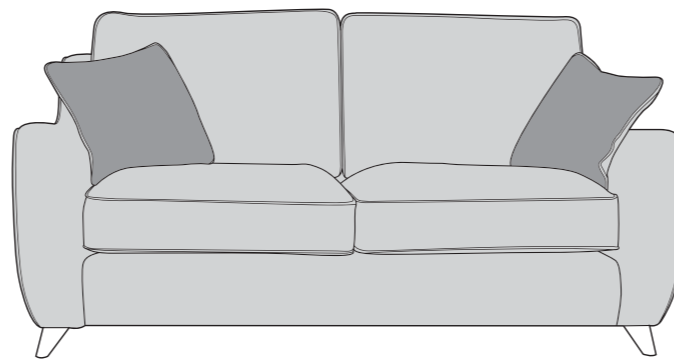

Arm Chair (1ST)

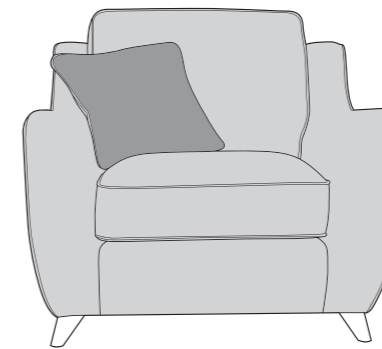

 **COVER 1**
(BODY)

 **COVER 2**
(SCATTER)

Scatter Cushion

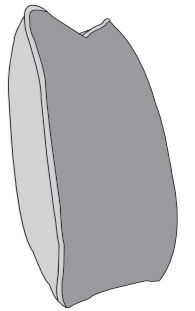

Front = Cover 2
Back = Cover 1
Piping = Cover 1

SUGGESTED ACCENT PIECES

Affinity Swivel Chair (SWC)

Footstool P (FST)

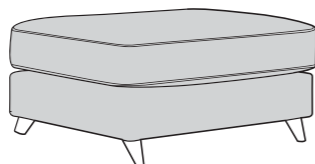
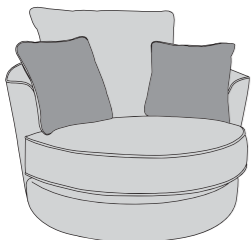

VARLEY DIMENSIONS (CM)

AVAILABLE PIECES	HEIGHT 1	WIDTH 2	DEPTH 3	SEAT HEIGHT 4	SEAT DEPTH 5	SEAT WIDTH 6	ACCESS DIAGONAL 7	OUTBACK HEIGHT 8	ARM HEIGHT 9	WEIGHT (KG)	SCATTER CUSHION NO.
LH2, COR, RH2 GROUP	89	282	282	47	N/A	N/A	N/A	74	63	134.5	3
LH2, RFC, FST or FST, LFC, RH2	89	282	255	47	N/A	N/A	N/A	74	63	114.5	3
LH2, COR, RH1 GROUP or LH1, COR, RH2 GROUP	89	282	203	47	N/A	N/A	N/A	74	63	129	3
LH1, COR, RH1 GROUP	89	203	203	47	N/A	N/A	N/A	74	63	94.5	3
LH2/RH2 UNIT	89	179	103	47	57	166	204	74	63	50	1
LH1/RH1 UNIT	89	100	103	47	57	86	114	74	63	35	1
LFC/RFC UNIT	89	185	103	47	57	139	208	74	63	48.5	2
COR - CORNER UNIT	89	103	103	47	57	57	146	74	63	34.5	1
ALU - ARMLESS UNIT	89	80	103	47	57	80	137	74	63	24.5	N/A
3 SEATER SOFA (3ST)											
2 SEATER SOFA (2ST)											
ARM CHAIR (1ST)											
ACCENT PIECES											
AFFINITY SWIVEL CHAIR (SWC)	90	114	111	N/A	N/A	N/A	N/A	N/A	N/A	34	2
FOOTSTOOL P (FST)	47	70	103	N/A	N/A	N/A	121	N/A	N/A	16	N/A

* Hardwood & composite board frame.

* Fibre filled backs for added comfort.

* Serpentine seat springs & silent wire.

* Dowelled, screwed, glued & stapled joinery.

* Award winning foamflex seat interior with 5 year guarantee.

* Superloop back springs.

* Light and Dark Wood foot options.

DIMENSION GUIDE

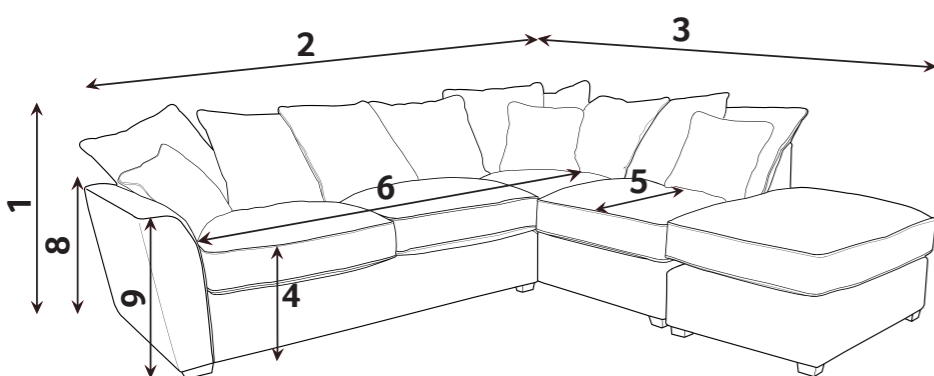

1 - HEIGHT
2 - WIDTH

3 - DEPTH
4 - SEAT HEIGHT

5 - SEAT DEPTH (STD & PILLOW)
6 - SEAT WIDTH

7 - DIAGONAL ACCESS
8 - OUTBACK HEIGHT
9 - ARM HEIGHT

Illustrations used for reference only.

Check the diagonal access dimension to ensure furniture will fit in your home.

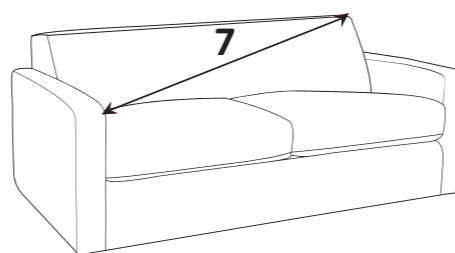

foamflex™

Our new expertly engineered foam seat interior gives you the comfort of fibre with the retention of foam.

CARE GUIDE

To improve the longevity of your hand-made furniture, we recommend rotating cushions (where applicable).

For further information on maintaining your furniture, please refer to the Care Guide located under the seat platform.



Our foamflex seat interiors have been granted the FIRA GOLD Award, a mark of quality under-pinning all necessary testing of the product materials, design and production techniques.

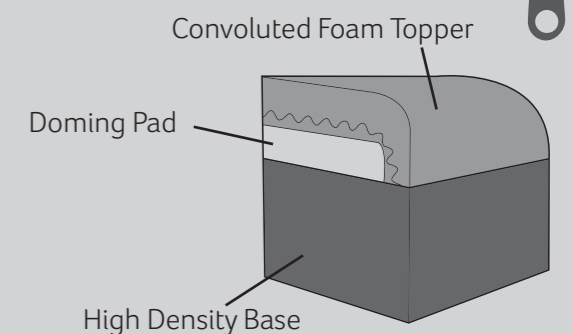

Dark (Antique)

Light (Beech)

FOOT OPTIONS:



Please note : All dimension are approximate. Allow tolerance of +/- 2.5cm.

Wood is a natural product and will vary in shade/colour from item to item. Feet require fitting.